

## ПЛАСТМАСОВИ ВЕРИГИ

### ALPHAbelt S1700.

Код : 401700-000

### ALPHAbelt S1701 TAB.

Код : 401701-000

### ALPHAbelt S1702.

Κωδικός: 401702-000

### Вериги за Завой R140.

#### Граница на счупване:

S1700	9000 Nw
S1701 TAB	9000 Nw
S1702	10000 Nw

#### Материали:

AC

АсетаI с нисък коефициент на триене (LF) на бял цвят.

SS

Съединителни звена от SS AISI 304

#### Сертификати:

Материалите са сертифицирани за пряк допир с хранителни стоки от FDA.

**Други материали:** Възможност да се произведат лентите и от други материали (според работните условия), след поръчка

**Стъпка:** 50 мм.

#### Опаковка:

На ролки по 5 метра (100 модула).

## ALPHAbelt S1700

S1700



S1701 TAB



S1702



S1700

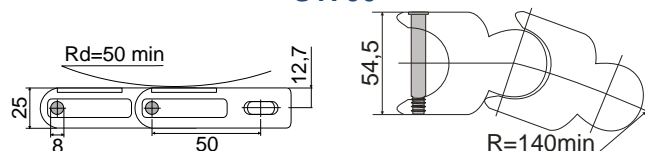

S1701 TAB

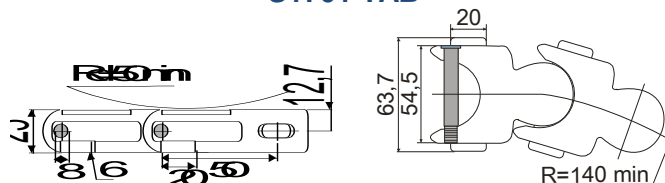

S1702

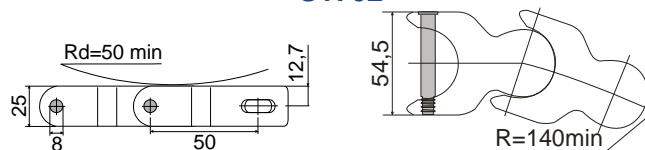

## ПЛАСТМАСОВИ ВЕРИГИ

## ALPHAbelt S1700

**Задвижващи Зъбни Колела S1700, S1701 TAB, 1702:**

Материал :Полиамид Стъкроукрепен (PAGF).



код	Z	F	A	B
404708-025	8	25	133	106
404708-030		30		
404710-025	10	25	165	139
404710-030		30		

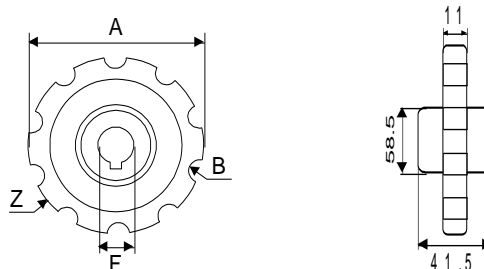

**Свободни Зъбни Колела S1700, S1701 TAB, 1702:**

Материал :Полиамид Стъкроукрепен (PAGF).



код	Z	F	A	B
404708-520	8	20	133	106
404708-525		25		
404708-530		30		
404710-520	10	20	165	139
404710-525		25		
404710-530		30		

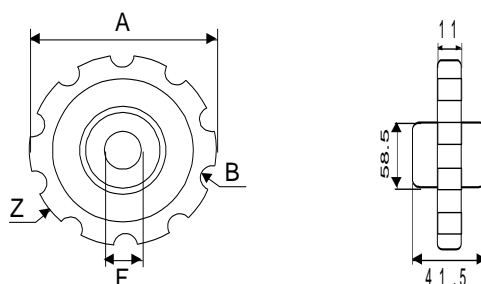

## ПЛАСТМАСОВИ ВЕРИГИ

### Плъзгачи за Завой S1700, S1701 TAB, S1702:

Материал : UHMW PE1000

Цвят : черен.

Опаковка : Чифт.

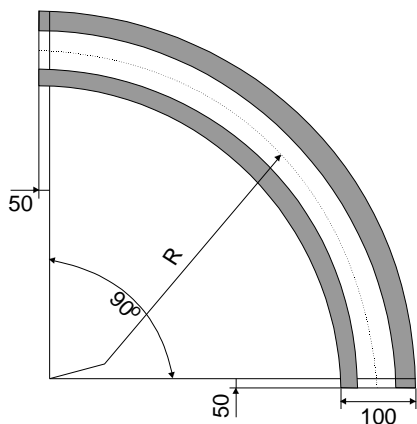

ЛЕНТА	КОД	R
S1700 & 1702	422019-113	250
S1700 & 1702	422019-114	500
S1701 TAB	422019-390	250
S1701 TAB	422019-391	500

## ALPHAbelt S1700

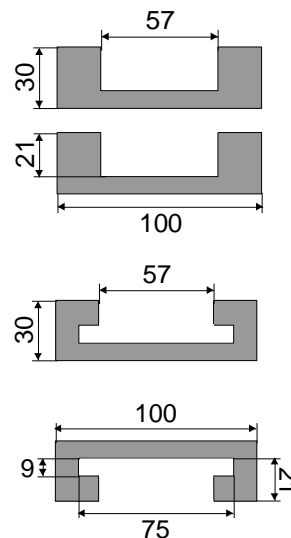
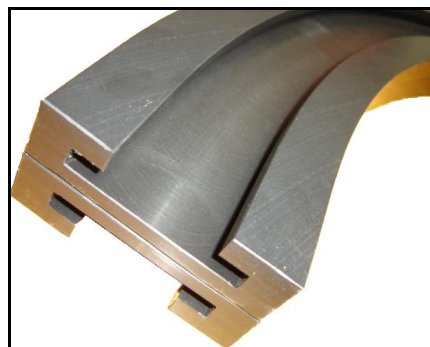

### Плъзгачи Прав Участък S1700, S1701 TAB, S1702:

Материал : UHMW PE1000

Цвят : черен.

Коридори: 1

ЛЕНТА	КОД	L
S1700 & 1702	422019-381	2000
S1701 TAB	422019-386	2000

